

Qualified Qest fittings

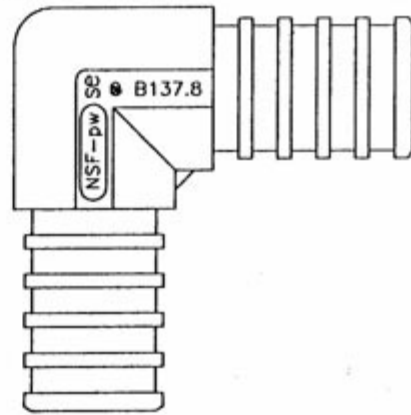

Qualified Qest fittings

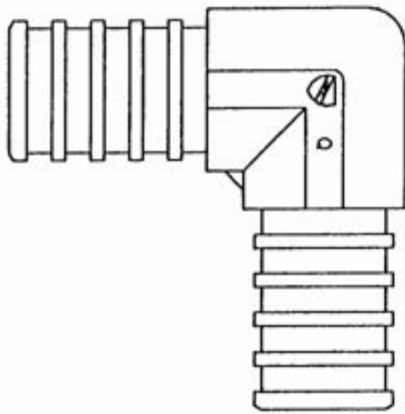
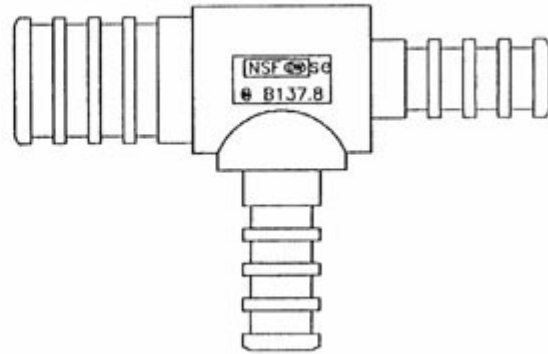
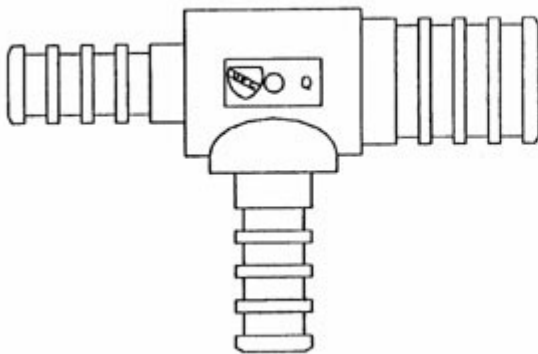

Qualified Qest pipe

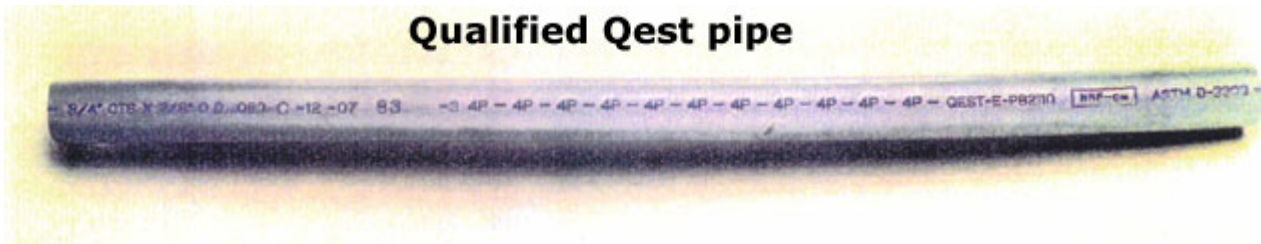

Qualified Qest pipe

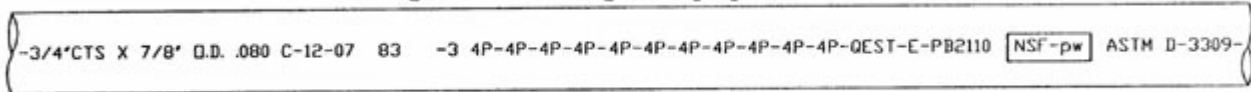

Qualified Vanguard fittings

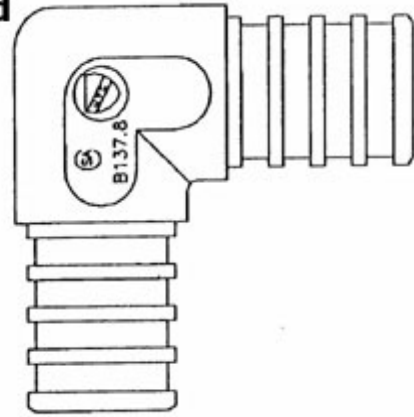
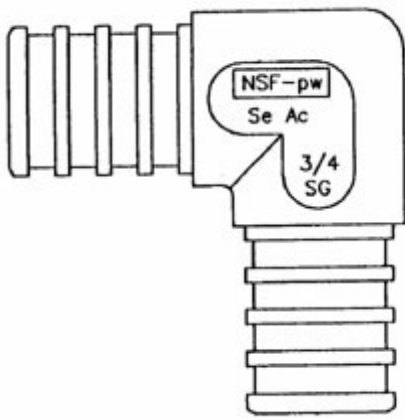

Qualified Vanguard fittings

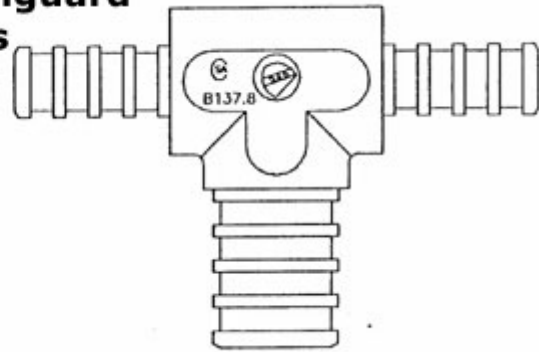
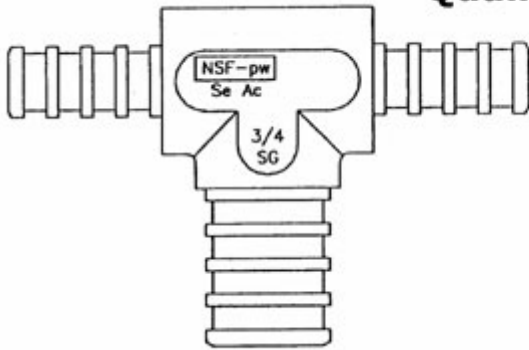

**Qualified Copper Insert Fittings
90-degree elbow and
"T" fitting**

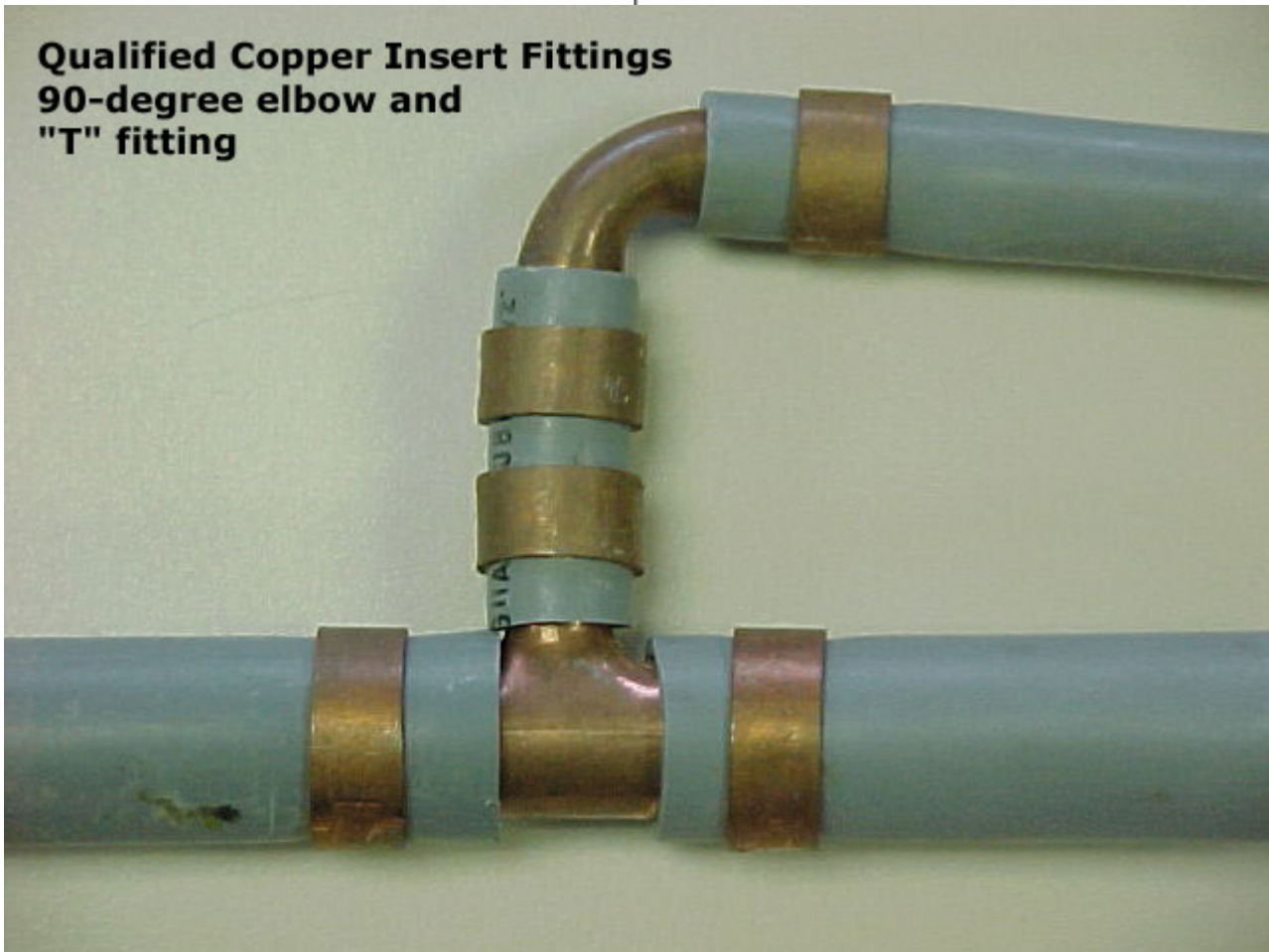

**Qualified Copper
"T" fitting**



**Qualified Copper
Insert Fitting**



**Qualified Copper
90-degree Elbow
Insert Fitting**



Non-qualified Brass Craft fittings

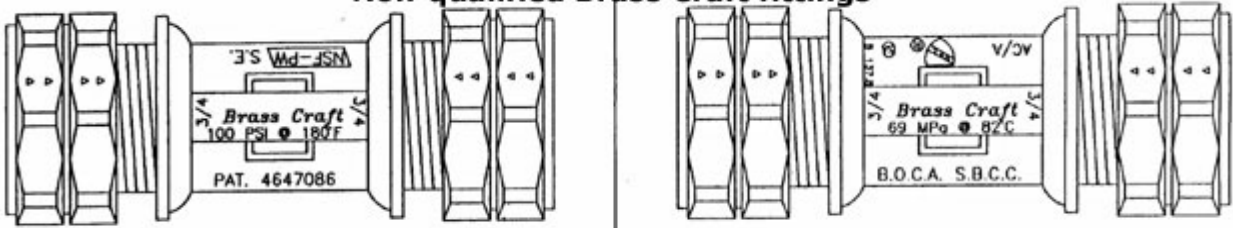

Non-qualified Qest fitting



Non-qualified Qest fitting

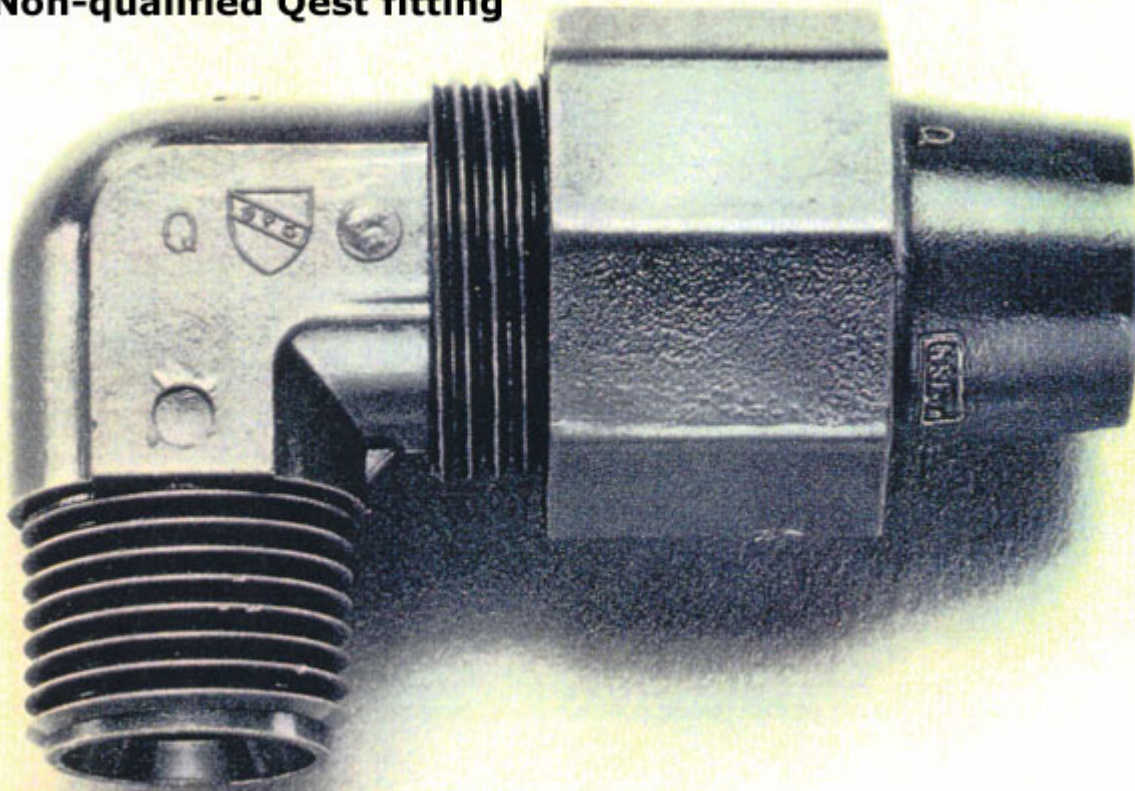

EXCLUDED PIPES and COMPONENTS

Note the exceptions explained below

Not Covered



VALVES - Typically found under sinks and toilets, are excluded.
Exceptions: If a wall must be cut to access the leak.

Not Covered

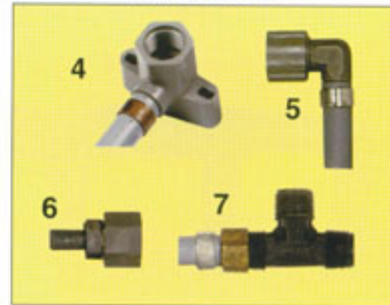

ADAPTERS - Typically used to connect polybutylene pipe to fixtures are excluded.
Exceptions: If a wall must be cut to access the leak.

Not Covered

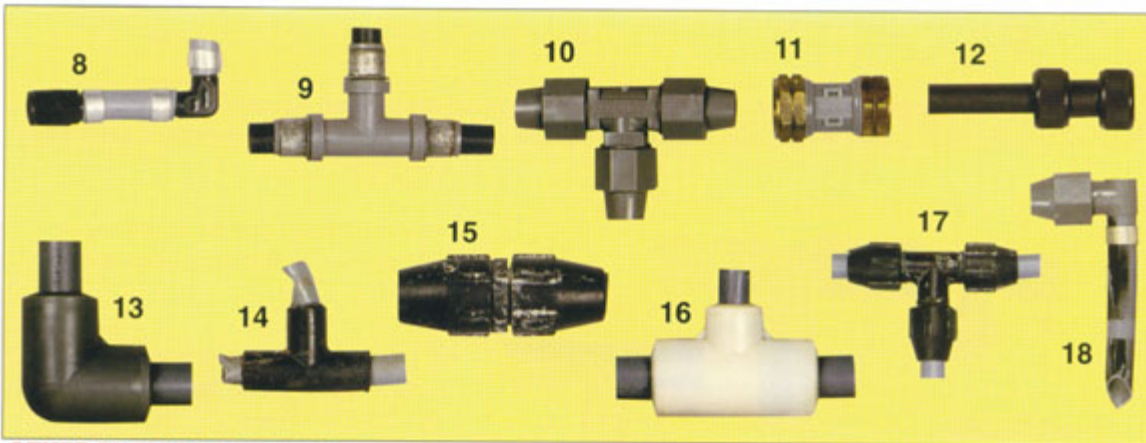

OTHER EXCLUDED FITTINGS - Homes that have been originally plumbed with polybutylene pipe with the above fittings are NOT eligible. **Exceptions:** If installed during a previous repair of the plumbing system.

Not Covered

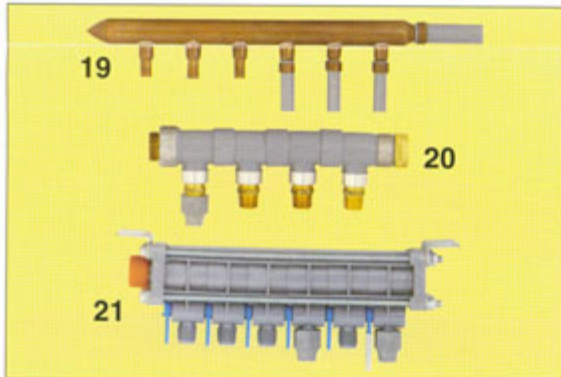

MANUFACTURED MANIFOLDS

These may be either metal (19) or plastic (20, 21).

Not Covered

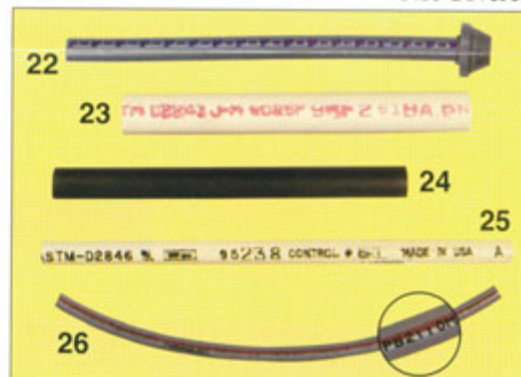

PIPES and RISERS. A riser (22) is a pipe running from a sink, toilet, or other fixture to a valve. Excluded pipe may be white PVC (23), black polyethylene (24), cream CPVC (25), or gray polybutylene pipe marked "PB 2110 M" (26).